

使用线径: 24-10AWG

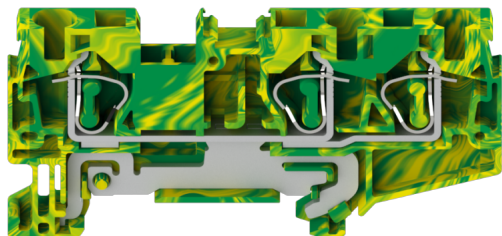

目录仅供参考，实际规格依产品工程图为准 版本1.0

技术数据-UL (1059)

接线范围 Wire Range [AWG]	24 ~ 10
-----------------------	---------

技术参数-IEC (60947-7-2)

单芯 Solid [mm ²]	0.2-6.0
柔性导线 Flexible [mm ²]	0.2-4.0
柔性导线带冷压头 Flexible with ferrule [mm ²]	0.2-4.0
过电压类别 Overvoltage Category	III
污染等级 Contamination Class	3
额定冲击电压 Impulse withstand voltage [KV]	8

材料 Material

绝缘材料 Insulation Material	PA66
阻燃等级 Flame retardant rating	UL94V-0

导体材料 Conductor Material	Copper alloy
导体表面镀层 Plating of conductor surface	Sn plated
一般参数 Other Date	
长/高/厚 Length/Height/Thickness [mm]	71.7/35.4/6.2
剥线长度 Stripping Length [mm]	8-10

尺寸图

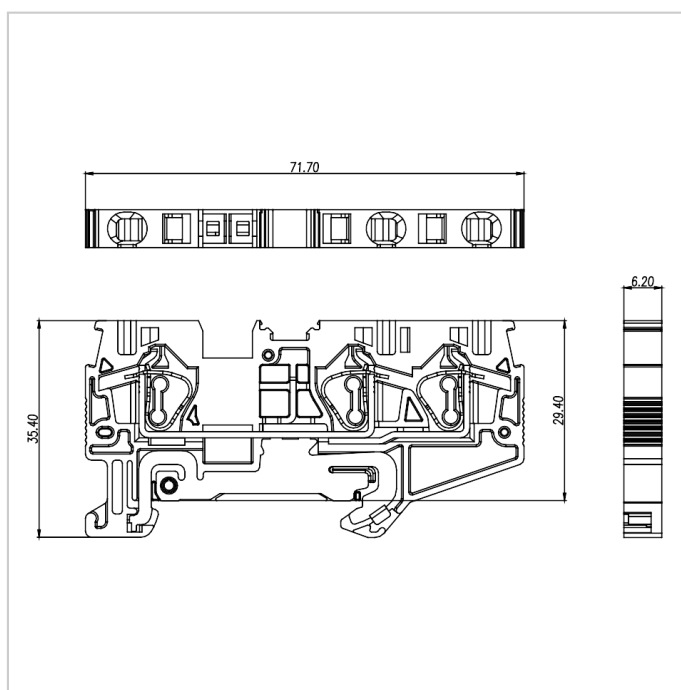

适配产品

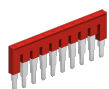

FUVA4-XX



DUS4-103



MUV4-10

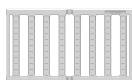

PUV4-80

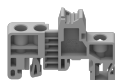

EB-35

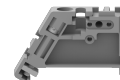

EW-35



DGL2-35x7.5A



DGL2-35x7.5B

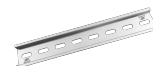

DGL2-35x7.5C



DGL2-35x7.5D