

使用线径: 24-10AWG

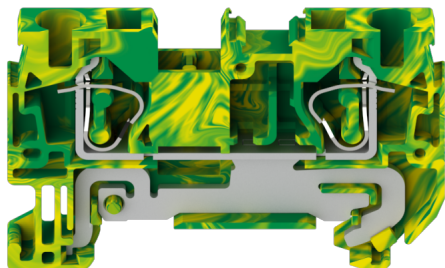

目录仅供参考，实际规格依产品工程图为准 版本1.0

技术数据-UL (1059)

| | |
|-----------------------|---------|
| 接线范围 Wire Range [AWG] | 24 ~ 10 |
|-----------------------|---------|

技术参数-IEC (60947-7-2)

| | |
|---|---------|
| 单芯 Solid [mm ²] | 0.2-6.0 |
| 柔性导线 Flexible [mm ²] | 0.2-4.0 |
| 柔性导线带冷压头 Flexible with ferrule [mm ²] | 0.2-4.0 |
| 过电压类别 Overvoltage Category | III |
| 污染等级 Contamination Class | 3 |
| 额定冲击电压 Impulse withstand voltage [KV] | 8 |

材料 Material

| | |
|-----------------------------|---------|
| 绝缘材料 Insulation Material | PA66 |
| 阻燃等级 Flame retardant rating | UL94V-0 |

| | |
|-------------------------------------|---------------|
| 导体材料 Conductor Material | Copper alloy |
| 导体表面镀层 Plating of conductor surface | Sn plated |
| 一般参数 Other Date | |
| 长/高/厚 Length/Height/Thickness [mm] | 56.0/35.4/6.2 |
| 剥线长度 Stripping Length [mm] | 8-10 |

尺寸图

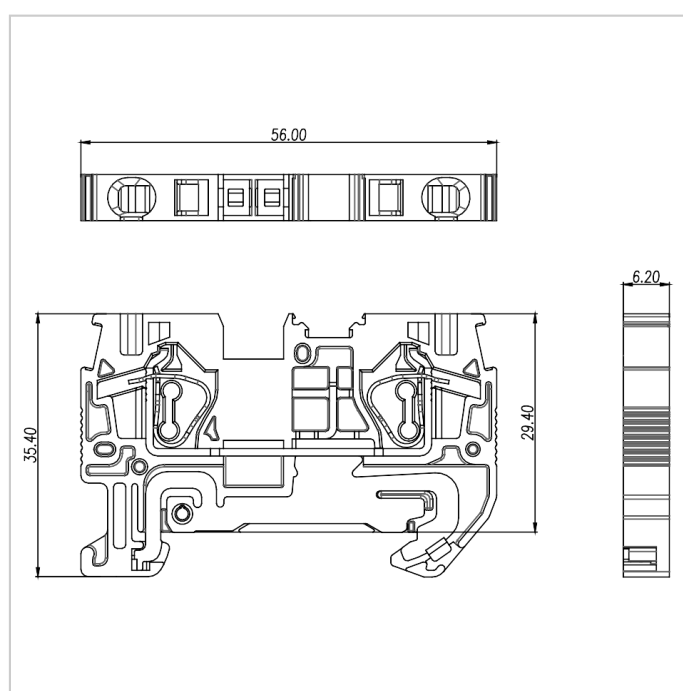

适配产品



DUV4-102

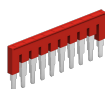

FUVA4-XX



MUV4-10

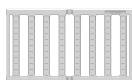

PUV4-80

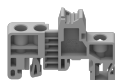

EB-35

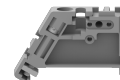

EW-35



DGL2-35x7.5A

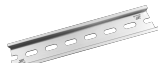

DGL2-35x7.5B

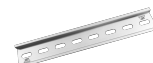

DGL2-35x7.5C



DGL2-35x7.5D