

Rated current: 15A  
Rated voltage: 300V  
spacing:7.62mm



The catalog is for reference only. The actual specifications are subject to the product engineering drawings. version 1.0

### UL/CUL

Use Group	B	C	D
Rate Voltage [V]	300	-	300
Rated Current [A]	15	-	10
Wire Range [AWG]		-	
Dielectric Voltage-Withstand		1.6KV	

### IEC

Overvoltage Category	III	III	II
Contamination Class	3	2	2
Rated Voltage [V]	250	320	630
Rated Current [A]	16	16	16

Impulse withstand voltage [KV]	6	6	6
Conductor cross section [mm <sup>2</sup> ]	-		

### Material

Insulation Material	PA66
Flame retardant rating	UL94V-0
Conductor Material	Copper alloy
Plating of conductor surface	Sn plated

### Other Data

Pitch/Poles [mm]/[P]	7.62/2-24
Stripping Length [mm]	-
Screw/Torque(Max)[N.m]	-
Operating temperature [°C]	-40 ~ +105
Soldering method	Wave soldering
Pin dimensions [mm]	1.2*1.2
PCB Hole Diameter [mm]	Ø2.0

### Dimensions

### PCB hole diagram

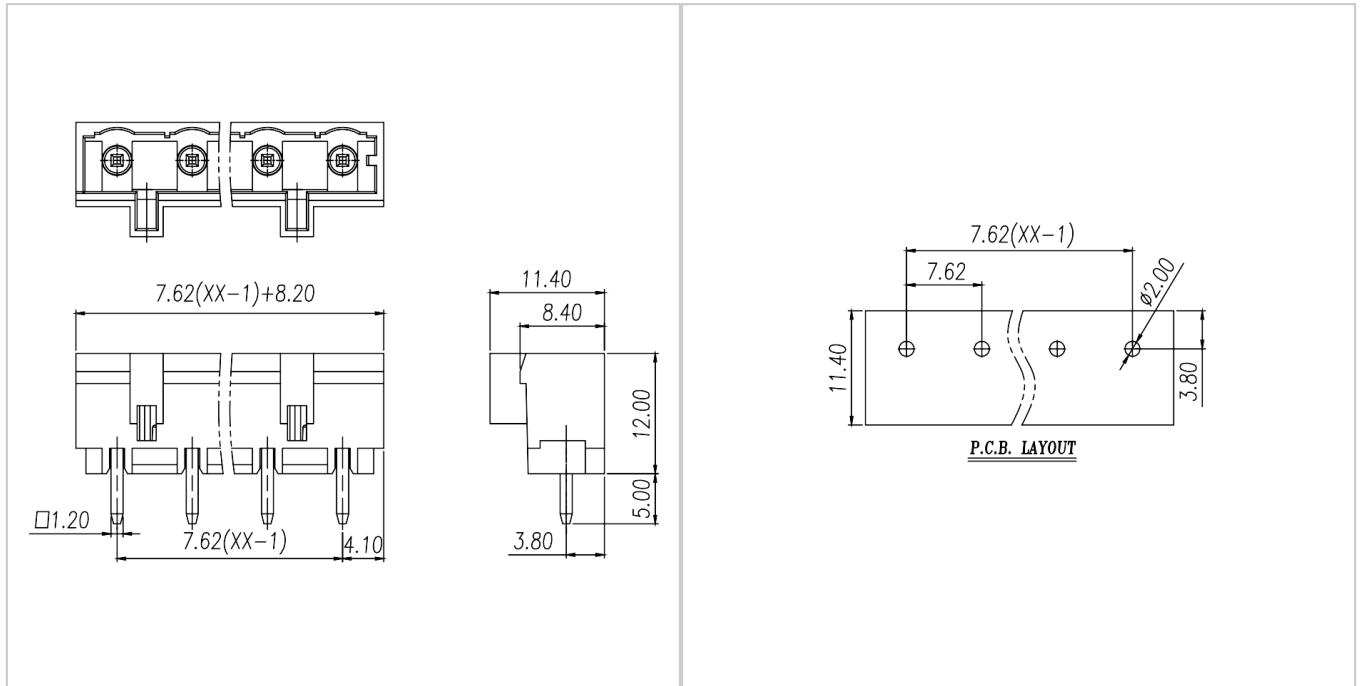

### Accessories



WJ0701-02XX



WJ0701-04XX



WJ0701-06XX



WJ0701-08XX



WJ0705-02XX



WJ0705-04XX