



Rated current: 15A

Rated voltage: 300V

Use wire diameter: 28-12AWG

spacing:7.62mm



The catalog is for reference only. The actual specifications are subject to the product engineering drawings. version 1.0

UL/CUL

Use Group	B	C	D
Rate Voltage [V]	300	-	300
Rated Current [A]	15	-	10
Wire Range [AWG]	28 ~ 12		
Dielectric Voltage-Withstand	1.6KV		

IEC

Overvoltage Category	III	III	II
Contamination Class	3	2	2
Rated Voltage [V]	320	320	630
Rated Current [A]	16	16	16

Impulse withstand voltage [KV]	6	6	6
Conductor cross section [mm ²]	0.25-2.5		

Material

Insulation Material	PA66
Flame retardant rating	UL94V-0
Conductor Material	Copper alloy
Plating of conductor surface	Sn plated

Other Date

Pitch/Poles [mm]/[P]	7.62/2-24
Stripping Length [mm]	8-9
Screw/Torque(Max)[N.m]	-
Operating temperature [°C]	-40 ~ +105

Dimensions

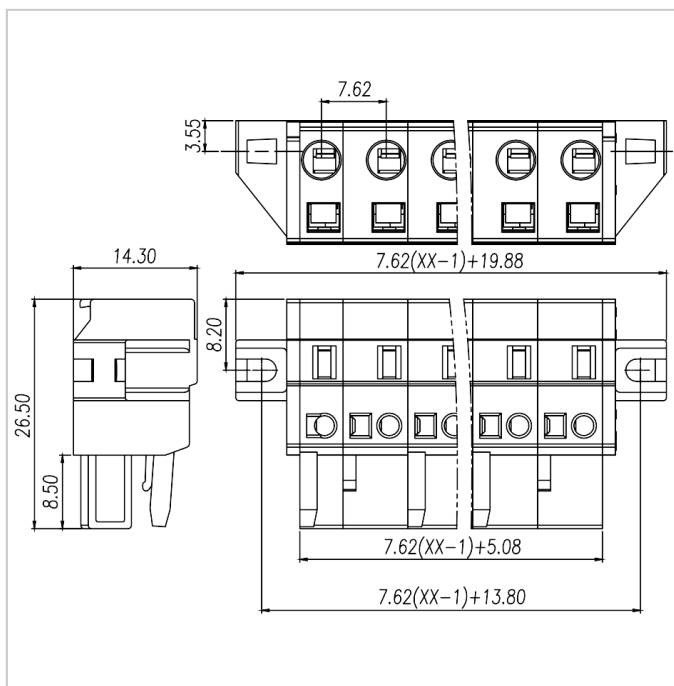

Accessories



WJ0702-01XX



WJ0702-02XX



WJ0702-03XX



WJ0702-04XX



WJ0703-01XX



WJ0703-02XX



WJ0703-03XX