



Rated current: 16A

Rated voltage: 300V

Use wire diameter: 28-12AWG

spacing:5.0mm



The catalog is for reference only. The actual specifications are subject to the product engineering drawings. version 1.0

UL/CUL

Use Group	B	C	D
Rate Voltage [V]	300	-	300
Rated Current [A]	16	-	10
Wire Range [AWG]	28-12		
Dielectric Voltage-Withstand	1.6KV		

IEC

Overvoltage Category	III	III	II
Contamination Class	3	2	2
Rated Voltage [V]	100	320	320
Rated Current [A]	10	10	10

Impulse withstand voltage [KV]	2.5	2.5	2.5
Conductor cross section [mm ²]	0.5-2.5		

Material

Insulation Material	PA66
Flame retardant rating	UL94V-0
Conductor Material	Copper alloy
Plating of conductor surface	Sn plated

Other Date

Pitch/Poles [mm]/[P]	5.0/2-24
Stripping Length [mm]	5-6
Screw/Torque(Max)[N.m]	M3/0.5
Operating temperature [°C]	-40 ~ +105

Dimensions

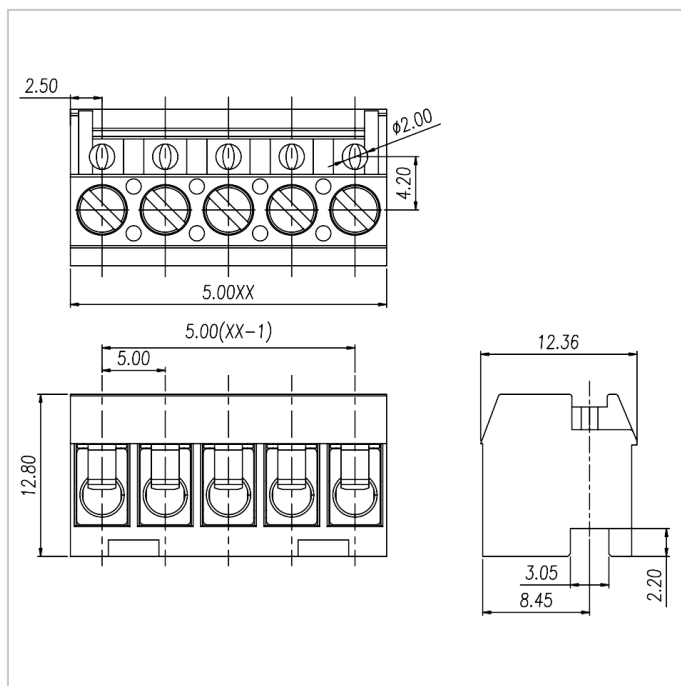

Accessories



WJ332J-5.0



WJ332J-THR-5.0