

Rated current: 8A
Rated voltage: 300V
spacing:3.81mm
Install: Wave soldering



The catalog is for reference only. The actual specifications are subject to the product engineering drawings. version 1.0

UL/CUL

Use Group	B	C	D
Rate Voltage [V]	300	-	300
Rated Current [A]	8	-	8
Wire Range [AWG]	-		
Dielectric Voltage-Withstand	1.6KV		

IEC

Overvoltage Category	III	III	II
Contamination Class	3	2	2
Rated Voltage [V]	160	160	320
Rated Current [A]	7	7	7

Impulse withstand voltage [KV]	2.5	2.5	2.5
Conductor cross section [mm ²]	-		

Material

Insulation Material	PA66
Flame retardant rating	UL94V-0
Conductor Material	Copper alloy
Plating of conductor surface	Sn plated

Other Date

Pitch/Poles [mm]/[P]	3.81/2*2-2*24
Stripping Length [mm]	-
Screw/Torque(Max)[N.m]	-
Operating temperature [°C]	-40 ~ +105
Soldering method	Wave soldering
Pin dimensions [mm]	0.8*0.8
PCB Hole Diameter [mm]	Ø1.4

Dimensions

PCB hole diagram

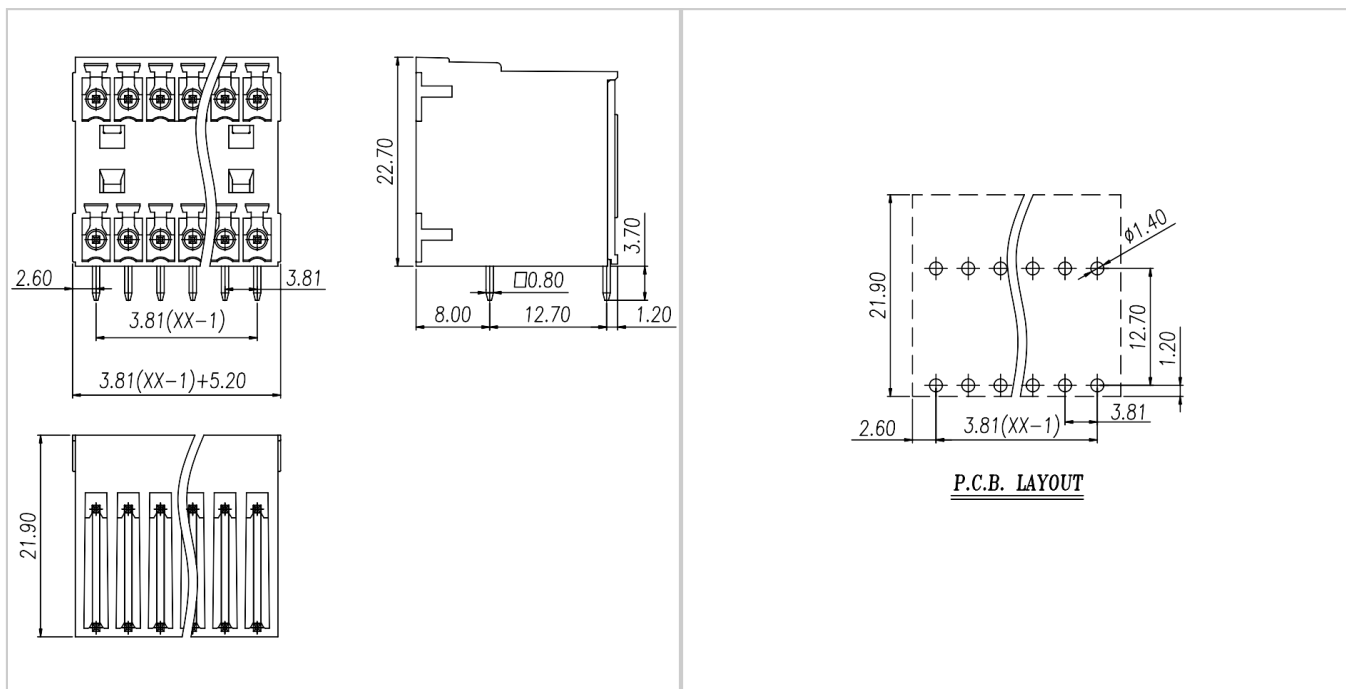

Accessories



WJ15EDGK-3.81



WJ15EDGKA-3.81



WJ15EDGKB-3.81



WJ15EDGKD-3.81