

Rated current: 50A

Rated voltage: 600V

Use wire diameter: 24-8AWG

The catalog is for reference only. The actual specifications are subject to the product engineering drawings. version 1.0

UL (1059)

Use Group	B	C	D
Rate Voltage [V]	600	600	600
Rated Current [A]	50	50	5
Wire Range [AWG]	24-8		

IEC (60947-7-1)

Rated Voltage [V]	1000
Rated Current [A]	41
Soild [mm ²]	0.2-10.0
Flexible [mm ²]	0.2-6.0
Flexible with ferrule [mm ²]	0.25-6.0

Overvoltage Category	III
Contamination Class	3
Impulse withstand voltage [KV]	8

Material

Insulation Material	PA66
Flame retardant rating	UL94V-0
Conductor Material	Copper alloy
Plating of conductor surface	Sn plated

Other Date

Length/Height/Thickness [mm]	43.3/42.0/8.2
Stripping Length [mm]	10-11
Screw/Torque [N.m]	M4/1.2-1.5

Dimensions

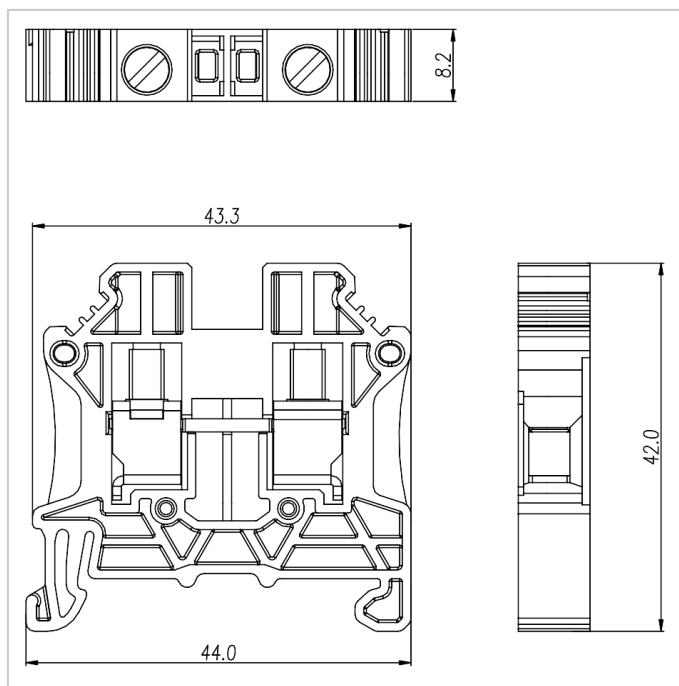

Accessories



FUVA6-XX



DUT10-102



MUV6-10

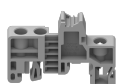

EB-35

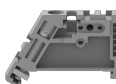

EW-35



EC-35



DGL2-35x7.5A

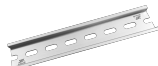

DGL2-35x7.5B



DGL2-35x7.5C



DGL2-35x7.5D