

Use wire diameter: 26-14AWG

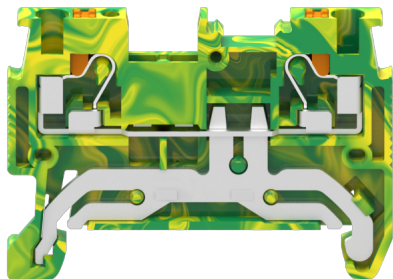

The catalog is for reference only. The actual specifications are subject to the product engineering drawings. version 1.0

UL ( 1059 )

Use Group	B	C	D
Wire Range [AWG]		26~14	

IEC ( 60947-7-2 )

Soild [mm <sup>2</sup> ]	0.2-1.5
Flexible [mm <sup>2</sup> ]	0.2-1.5
Flexible with ferrule [mm <sup>2</sup> ]	0.2-1.0
Overvoltage Category	III
Contamination Class	3
Impulse withstand voltage [KV]	6

Material

Insulation Material	PA66
Flame retardant rating	UL94V-0
Conductor Material	Copper alloy
Plating of conductor surface	Sn plated

Other Date

Length/Height/Thickness [mm]	45.0/30.6/3.5
Stripping Length [mm]	8-10

Dimensions

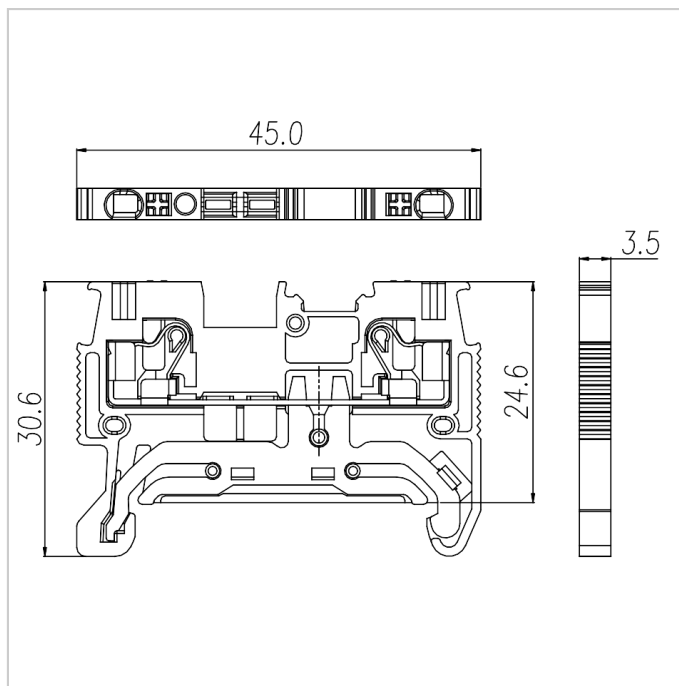

Accessories

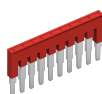

DUV1.5-102



FUVA1.5-XX

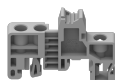

MUV1.5-10



PUV1.5-144



EB-35



EW-35



DGL2-35x7.5A



DGL2-35x7.5B

DGL2-35x7.5C

DGL2-35x7.5D