



插拔式连接器

额定电流: 15 A

额定电压: 300 V

使用线径: 28-12 AWG

间距: 5.08 mm



目录仅供参考，实际规格依产品工程图为准 版本1.0

技术数据-UL/CUL

等级 Use Group	B	C	D
额定电压 Rate Voltage [V]	300	-	300
额定电流 Rated Current [A]	15	-	10
接线范围 Wire Range [AWG]	28-12		
耐电压 Dielectric Voltage-Withstand	1.6KV		

技术参数-IEC

过电压类别 Overvoltage Category	III	III	II
污染等级 Contamination Class	3	2	2
额定电压 Rated Voltage [V]	250	320	630
额定电流 Rated Current [A]	15	15	15
额定冲击电压 Impulse withstand voltage [KV]	4	4	4
导线截面积[硬/柔] Conductor cross section [mm ²]	0.2-2.5		

材料 Material

绝缘材料 Insulation Material	PA66
--------------------------	------

阻燃等级 Flame retardant rating	UL94V-0
导体材料 Conductor Material	Copper alloy
导体表面镀层 Plating of conductor surface	Sn plated

一般参数 Other Data

间距/极数 Pitch/Poles [mm]/[P]	5.08/2-24
剥线长度 Stripping Length [mm]	7-8
螺丝/扭矩 Screw/Torque(Max)[N.m]	M3/0.5
工作温度 Operating temperature [°C]	-40~+105
焊锡温度 Soldering temperature	/
引针尺寸 Pin dimensions [mm]	/
PCB板孔径 PCB Hole Diameter [mm]	/

尺寸图

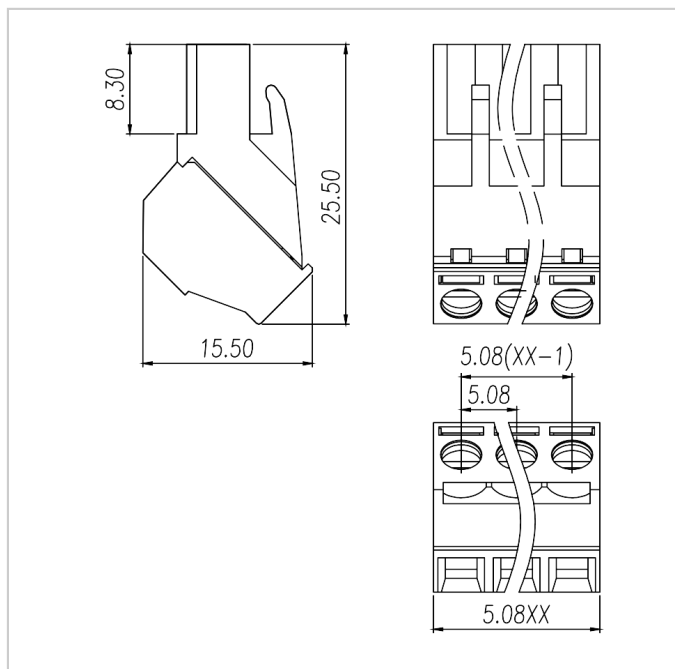

配件



WJ2EDGV-5.0/5.08

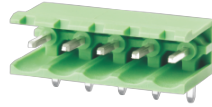

WJ2EDGR-5.0/5.08



WJ2EDGVC-5.0/5.08

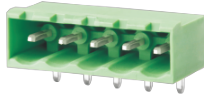

WJ2EDGRC-5.0/5.08



WJ2EDGV-THT-5.0/5.08



WJ2EDGVC-THT-5.0/5.08



WJ2EDGR-THT-5.0/5.08



WJ2EDGRC-THT-5.0/5.08

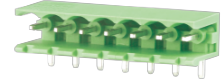

WJ2EDGRR-5.0/5.08

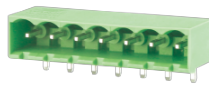

WJ2EDGRR-5.0/5.08

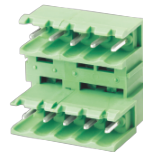

WJ2EDGVT-5.0/5.08

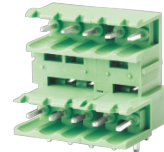

WJ2EDGRT-5.0/5.08



WJ2EDGVTC-5.0/5.08



WJ2EDGRTC-5.0/5.08



WJ2EDGVH-5.0/5.08



WJ2EDGRH-5.0/5.08



WJ2EDGL-5.0/5.08



WJ2EDGLC-5.0/5.08



WJ2EDGKDR-5.0/5.08

WJ2EDGKR-5.0/5.08

WJ2EDGKRZ-5.0/5.08