

电路图：

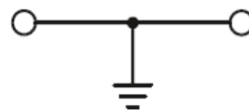

目录仅供参考，实际规格依产品工程图为准 版本1.0

### 技术参数-UL ( 1059 )

接线范围 Wire Range	24-8
-----------------	------

### 技术参数-IEC(60947-7-2)

过电压类别 Overvoltage Category	III
污染等级 Contamination Class	3

### 导线截面积 Conductor cross section

单芯 Solid	0.2-6.0mm <sup>2</sup>
柔性导线 Flexible	0.2-6.0mm <sup>2</sup>
柔性导线带冷压头 Flexible with ferrule	0.2-4.0mm <sup>2</sup>

### 材料 Material

绝缘材料 Insulation Material	PA66
阻燃等级 Flame retardant rating	UL94V-0

### 一般参数 Other Data

连接点数 Connection Points	2
剥线长度 Stripping Length [mm]	8-10

导轨类型 Type of rail	DIN 35 / DIN 32
螺丝/扭矩 Screw/Torque(Max)[N.m]	M4/1.5-1.8
工作温度 Operating temperature [°C]	-40°C~+105°C
长/高/厚 Length/Height/Thickness [mm]	42.9/45.8/8.2

### 尺寸图

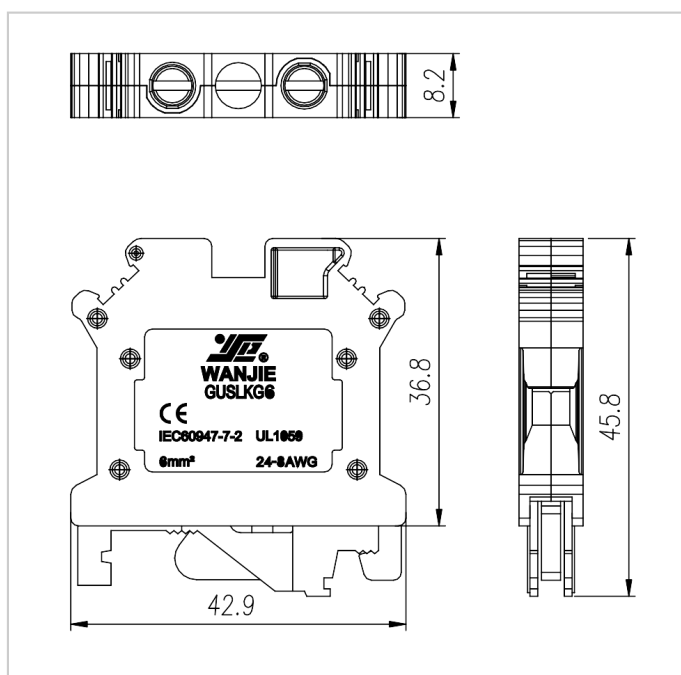

### 配件

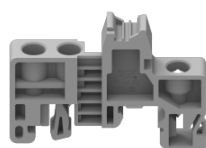

EB-35

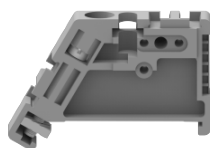

EW-35



DGL2-35x7.5A

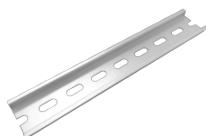

DGL2-35x7.5B

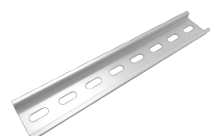

DGL2-35x7.5C



DGL2-35x7.5D



MUV6-10



DGS1-35x7.5W4.2x12



DGS1-35x7.5W5.2x15



DGS1-35x7.5W

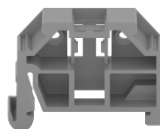

EC-35