

PCB connector

Rated current: 8 A

Rated voltage: 300 V

Wire range: 24-16 AWG

Pitch: 3.5 mm/3.81 mm

Connection method: Push-in spring connection



For reference only!version1.0

UL/CUL

Use Group	B	C	D
Rate Voltage [V]	300	-	300
Rated Current [A]	8	-	8
Wire Range [AWG]	24~16		
Dielectric Voltage-Withstand	1.6KV		

IEC

Overvoltage Category	III	III	II
Contamination Class	3	2	2
Rated Voltage [V]	160	160	320
Rated Current [A]	8	8	8
Impulse withstand voltage [KV]	2.5	2.5	2.5
Conductor cross section[solid/flexible] [mm²]	0.2~1.5		

Material

Insulation Material	PA66
Flame retardant rating	UL94V-0
Conductor Material	Copper alloy
Plating of conductor surface	Sn plated

Other Data

Pitch/Poles [mm]/[P]	3.5 , 3.81/2~24
Stripping Length [mm]	9~10
Screw/Torque(Max)[N.m]	/
Operating temperature [°C]	-40~+105
Soldering temperature	/
Pin dimensions [mm]	/
PCB Hole Diameter [mm]	/

Dimensions

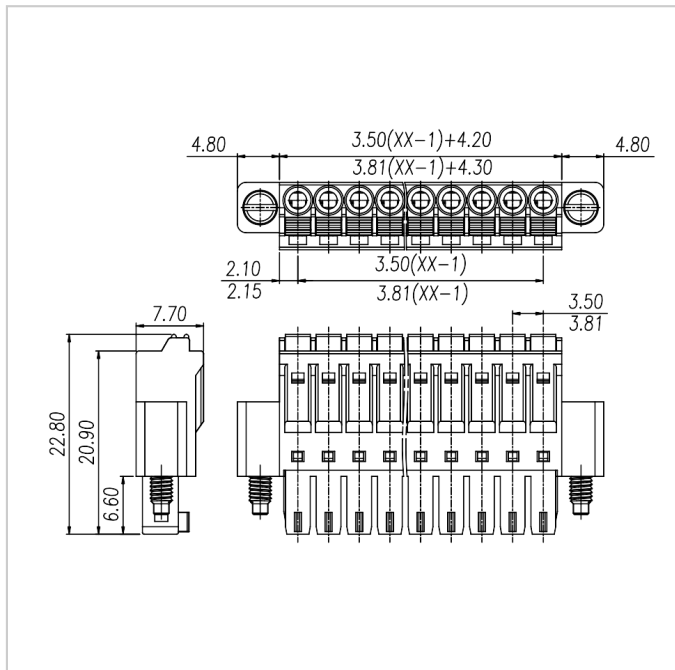

Accessories

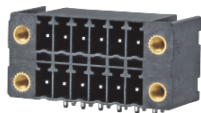
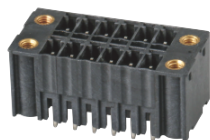

[WJ15EDGVHBM-THT-3.5/3.81](#)

[WJ15EDGRHBM-THT-3.5/3.81](#)

[WJ15EDGVM-THR-3.5/3.81](#)

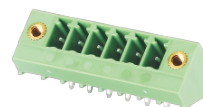
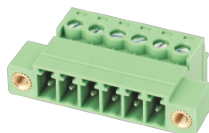

[WJ15EDGRM-THR-3.5/3.81](#)

[WJ15EDGKRN-3.81](#)

[WJ15EDGLM-3.5/3.81](#)

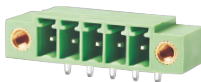
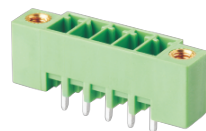

[WJ15EDGVM-3.5/3.81](#)

[WJ15EDGRM-3.5/3.81](#)

[WJ15EDGVH3M-3.5](#)

[WJ15EDGRH3M-3.5](#)

[WJ15EDGVH3M-THT-3.5](#)

[WJ15EDGRH3M-THT-3.5](#)