

MCS terminal Block

Rated current: 15 A

Rated voltage: 300 V

Pitch: 7.5 mm/7.62 mm



For reference only!version1.0

UL/CUL

Use Group	B	C	D
Rate Voltage [V]	300	-	300
Rated Current [A]	15	-	10
Wire Range [AWG]	/		
Dielectric Voltage-Withstand	1.6KV		

IEC

Overvoltage Category	III	III	II
Contamination Class	3	2	2
Rated Voltage [V]	250	320	630
Rated Current [A]	16	16	16
Impulse withstand voltage [KV]	6	6	6
Conductor cross section[solid/flexible] [mm²]	/		

Material

Insulation Material	PA66
Flame relardant rating	UL94V-0

Conductor Material	Copper alloy
Plating of conductor surface	Sn plated

Other Data

Pitch/Poles [mm]/[P]	7.5 , 7.62/2-24
Stripping Length [mm]	/
Screw/Torque(Max)[N.m]	/
Operating temperature [°C]	-40~+105
Soldering temperature	260°C/5S
Pin dimensions [mm]	1.2*1.2
PCB Hole Diameter [mm]	Ø2.0

Dimensions

PCB opening diagram

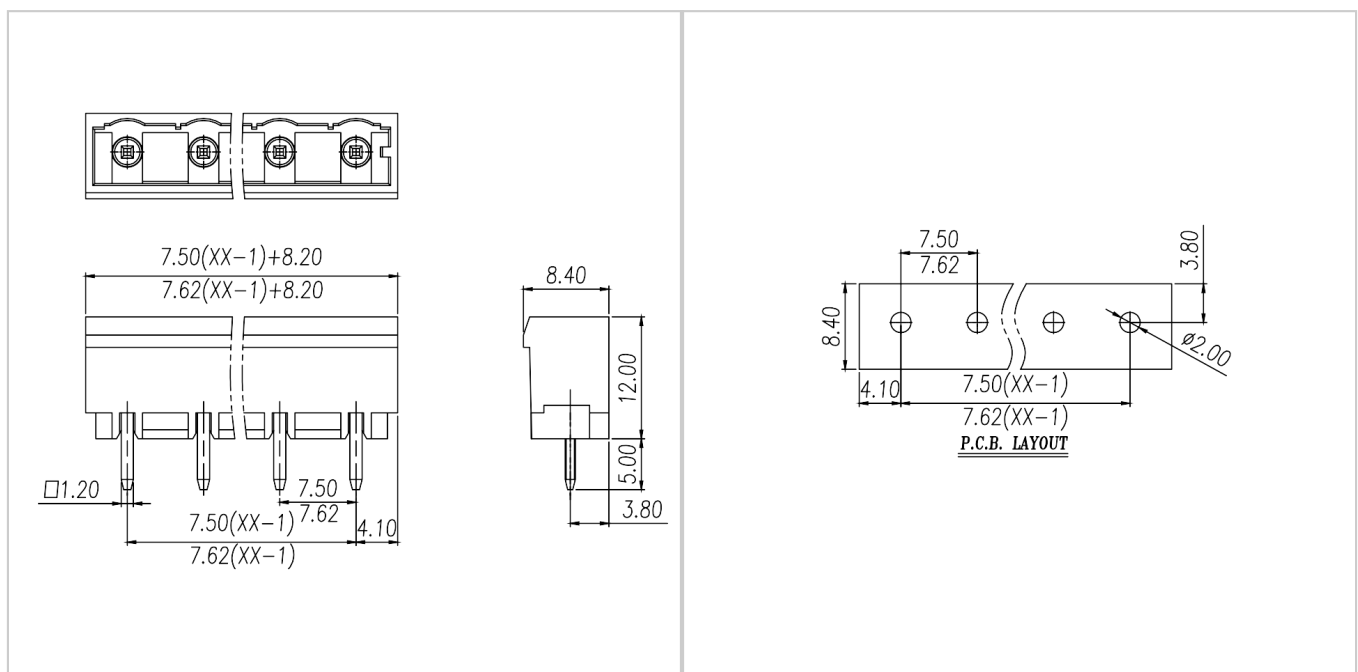

Accessories



[WJ0601/0701-01XX](#)



[WJ0601/0701-03XX](#)



[WJ0601/0701-05XX](#)



[WJ0601/0701-07XX](#)

[WJ0605/0705-01XX](#)

[WJ0605/0705-03XX](#)